

REV.	DESCRIPTION	DRAWN	CHECKED	APPROVED
A	NEW RELEASE	LJH 09/24/05'	~	LJC 09/24/05'
B	ADD 50pin drawing	LJC 02/10/07'	~	LJC 06/16/07'
C	ADD BR TYPE	YCH 07/10/07'	~	LJC 07/10/07'
D	REDRAWING	YCH 12/12/05'	~	LJC 12/12/05'
E	ADD P/N CODE	LJC 12/22/13'		

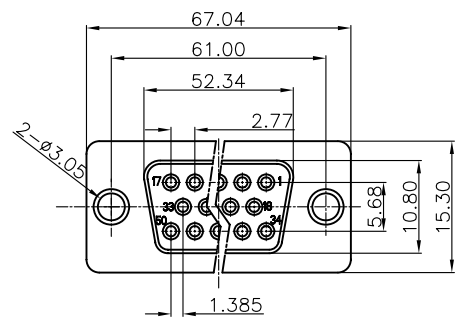

50pin Female Figure

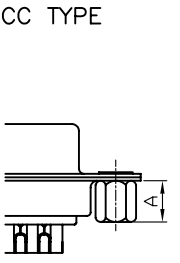
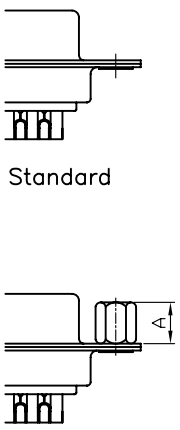
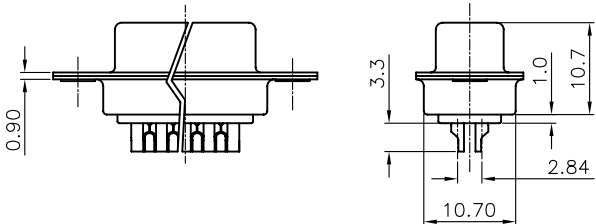
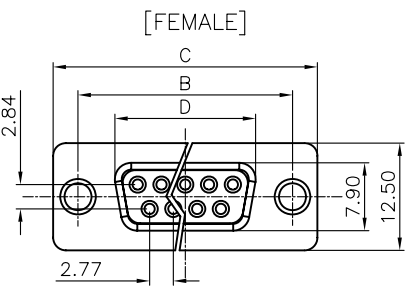
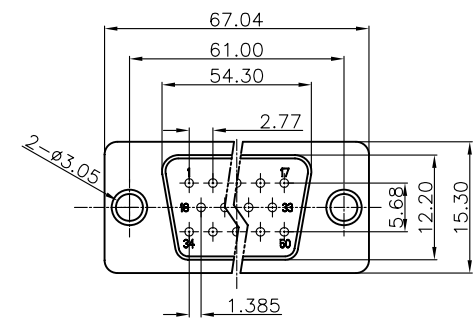

50pin Male Figure

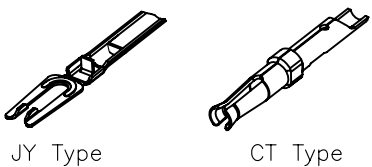
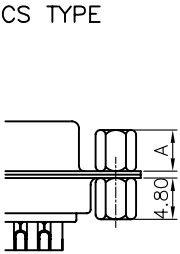

CSH TYPE

JY Type

CT Type

- NOTES:
- ELECTRICAL CHARACTERISTICS:
 - CONTACT RESISTANCE: 20mΩ Max. INITIAL.
 - DIELECTRIC WITHSTANDING VOLTAGE: 500V AC(rms) FOR 1 MINUTE.
 - INSULATION RESISTANCE: 1000MΩ Min.
 - ENVIRONMENT CHARACTERISTICS:
 - TEMPERATURE RANGE: -40°C~+105°C.
 - PRODUCT NUMBER CODE: DS1033- X X X X X X X - X

- CONTACT TYPE ⊕
- JY: JY TYPE
- CT: CT TYPE
- SCREW DIM. A
- S: Standard(W/O nut)
- 1: 5.00
- 2: 3.00
- 3: 5.20
- 4: 4.80
- 5: 5.80
- 6: 4.00
- SCREW TYPE
- S: Standard(W/O nut)
- 1: CC TYPE
- 2: CS TYPE
- 3: CSH TYPE
- CONTACT PLATING
- 8: FULL GOLD FLASH
- Si: SELECTIVE GOLD FLASH
- 6: Full Tin
- SHELL PLATING
- T: FRONT & BACK Tin
- N: FRONT Nickel, BACK Tin
- HOUSING COLOR
- B: BLACK
- W: WHITE
- U: BLUE
- CONNECTOR TYPE
- M: Male
- F: Female
- No. OF CONTACTS
- 09,15,25,37,50

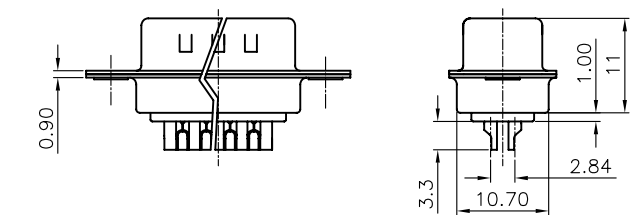
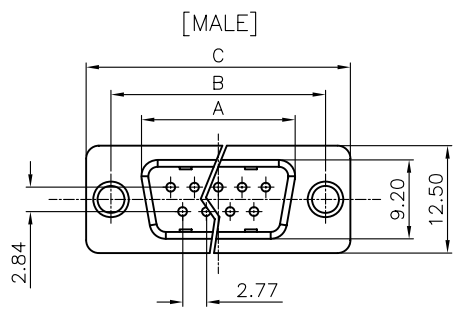

Dimension

Position	A±0.2	B±0.2	C±0.3	D
9	17.90	24.99	30.80	16.33
15	26.50	33.32	39.14	24.66
25	40.00	47.04	53.04	38.38
37	56.50	63.50	69.32	54.84

GENERAL TOLERANCE		ANGLE TOLERANCE	
X.	±0.60	X.	±5°
.X	±0.38	.X	±3°
.XX	±0.25	.XX	±2°

PROJECTION	TITLE	D-SUB STANDARD SOLDER TYPE	
UNITS	mm	SHEET	1 OF 1
SHEET SIZE	A4	SERIES	DS1033 SERIES

DRAWING TYPE	CUSTOMER		
SCALE	1:1	SHEET	1 OF 1
DRAWING NO.	C-DS1033-XXXXXXX-X-E		

晨翔电子有限公司
CONNFLY® CONNFLY ELECTRONIC CO., LTD